

Notes :

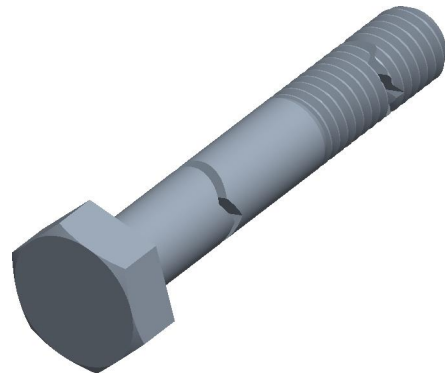

virtual3dcatalog.com		THIRD ANGLE PROJECTION	
<p>This file and the related information are provided for reference only and may change without notice. Manufacturer does not guarantee the accuracy, completeness, or suitability of this file or the information provided. You are responsible for how you use this file and its information.</p>		<p>This document is the property of Manufacturer. The information in it may not be copied, shared, or given to any third party without written permission from Manufacturer.</p>	
TITLE SET SCREW		DESCRIPTION	
Sheet Size	PART NUMBER	Rev.	ISSUED
A		05	2026-04-09
SCALE: 1.563		Unless otherwise specified Dimensions are in	