

Notes :

1. Category: Carriage Bolts
2. System of Measurement: Metric
3. Head Style: Round Head
4. Head Style Detail: Square Neck
5. Thread Length: Standard Thread Length
6. Thread Direction: Right-Hand Thread
7. Material: Steel
8. Material Grade: Class 4.6 Steel
9. Coating: Zinc Plated
10. Standards and Specifications: DIN 603 / ISO 8677

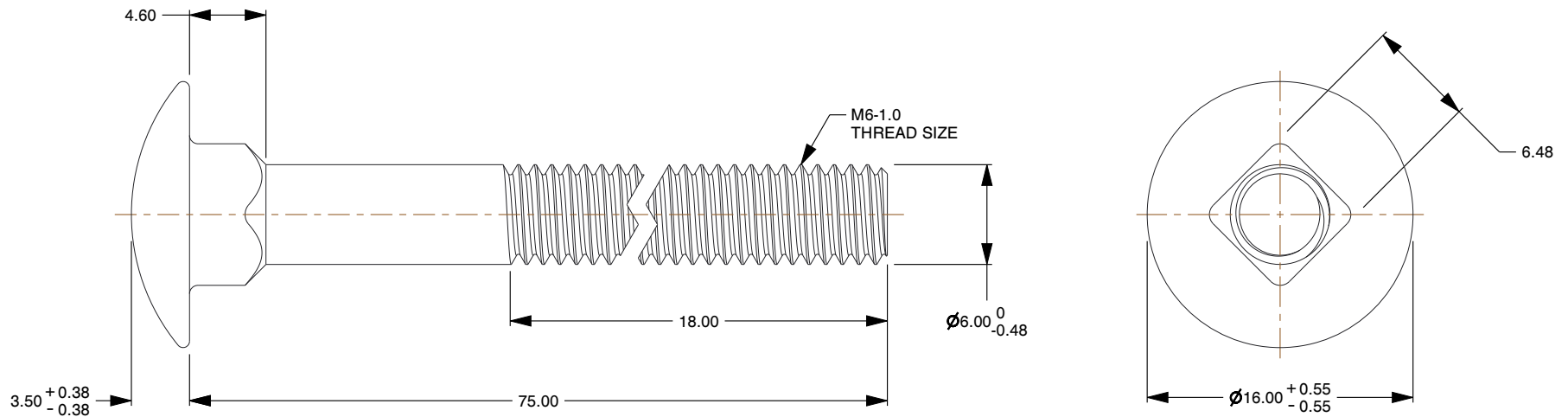
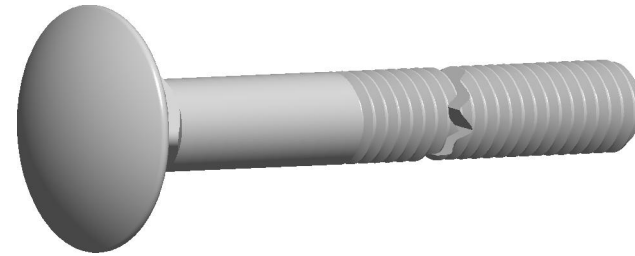

	This file and any associated information and specifications are provided for reference and evaluation purpose only, and is subject to change without notice. _____ makes no representations, warranties or guarantees as to the appropriateness, accuracy, completeness or suitability for any purpose of the file, information or specification. You are solely responsible for the use of the file, information and specifications	This drawing is the property of _____. It contains confidential proprietary information that is _____ property. Do not disclose to or duplicate for others except as authorized by _____	<p align="center">PRODUCT NAME</p> <p align="center">M6-1.0 X 75mm DIN 603 / ISO 8677, Metric, Carriage Bolts, Round Head, Square Neck, Class 4.6 Steel, Zinc</p>	UNIT MILLIMETERS
				ISSUED 2023-03-30
		SCALE 2.543	PART NUMBER: CB105-610X75	SHEET 1 of 1