

Notes :

1. Category: Carriage Bolts
2. System of Measurement: Metric
3. Head Style: Round Head
4. Head Style Detail: Square Neck
5. Thread Length: Standard Thread Length
6. Thread Direction: Right-Hand Thread
7. Material: Steel
8. Material Grade: Class 4.6 Steel
9. Coating: Zinc Plated
10. Standards and Specifications: DIN 603 / ISO 8677

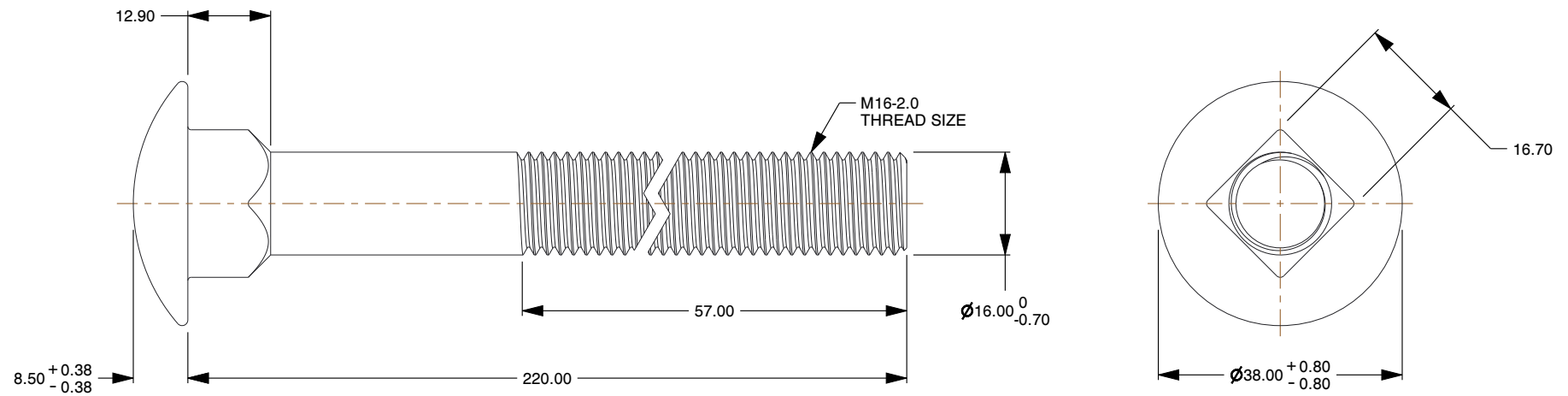
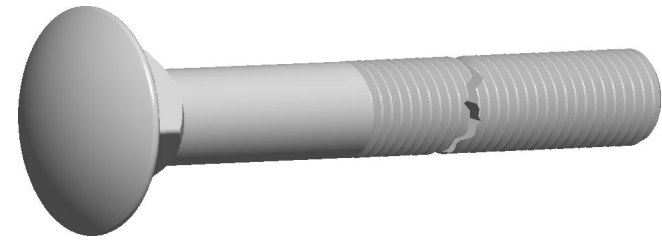

	This file and any associated information and specifications are provided for reference and evaluation purpose only, and is subject to change without notice. _____ makes no representations, warranties or guarantees as to the appropriateness, accuracy, completeness or suitability for any purpose of the file, information or specification. You are solely responsible for the use of the file, information and specifications	This drawing is the property of _____. It contains confidential proprietary information that is _____ property. Do not disclose to or duplicate for others except as authorized by _____	PRODUCT NAME	UNIT
			M16-2.0 X 220mm DIN 603 / ISO 8677, Metric, Carriage Bolts, Round Head, Square Neck, Class 4.6 Steel, Zinc	MILLIMETERS
			PART NUMBER: CB105-1620X220	ISSUED 2023-03-30
		SCALE 0.994		SHEET 1 of 1